



Motic®

MORE THAN MICROSCOPY

BA310 | ADVANCED UPRIGHT MICROSCOPE



BA310 | ADVANCED UPRIGHT MICROSCOPE



The new **BA310** from **Motic** is designed specifically for the rigors of daily routine work in the demanding applications of **Universities, Clinics, Laboratories**, and any other life science or medical application requiring **quality optical performance**.

Using Motic's Color Corrected Infinity Optics (**CCIS®**) with **newly designed EF-N Plan Achromats**, this model's full Koehler configuration provides maximum illumination quality for even the most demanding samples. Also, the BA310's upgradeability to include additional contrast methods and discussion devices, ensure this model will offer **long term functionality to all user levels** in a variety of applications.



The new BA310 Series

The demands placed on any routine microscope for daily work needs careful focus on every microscope detail. In this new design, Motic has paid careful attention to optimize the new BA310 features in all respects.

The 30W illumination provides the user with a **powerful and adjustable light source** to meet both delicate and detailed lighting requirements for all sample types, while the **fully featured Koehler illumination** of the BA310 helps to evaluate even the weakest stained specimens.

Motic's new EF-N Plan Achromat objectives provide optimal image contrast through newly designed **multi-layer lens coatings**. **The new fully corrected tube lens** and subsequent intermediate image without color fringes is now fully accessible through both eyepiece and trinocular port, making digital images as crisp and clear as those seen through the eyepieces.

The new BA310 design also includes a standardized **ISO photo exit**. The BA310's large, **hard coated and chemical resistant stage**, with an expansive 76x50mm travel range, includes a **new slide holder with improved tighter grip**. This ensures easy and repeatable scanning of numerous slides in all daily routines.



New Motic
EF-N Plan Achromats

Objectives

To improve the overall optical performance of the BA310, Motic introduces a newly designed generation of Plan Achromatic Objectives made of **high quality optical glass; CCIS® EF-N Plan**. These new lenses are now multi-layer coated for **improved contrast** to enhance images even with weak slide stainings.

Together with a new calculated tube lens, the result is a **fully corrected, perfected intermediate image without colored fringes**. The Trinocular BA310 gives digital access for even sharper imaging and improved digital output quality for professional results at student level.

Magnification	N.A.	W.D. (mm)
EF-N Plan 4X	0.10	6,3
EF-N Plan 10X	0.25	4,4
EF-N Plan 20X	0.40	4,66
EF-N Plan 40X, Spring	0.65	0,35
EF-N Plan 60X, Spring	0.85	0,13
EF-N Plan 100X, Spring, Oil	1.25	0,13
EF-N Plan Phase 10X	0.25	4,4
EF-N Plan Phase 40X, Spring	0.65	0,35

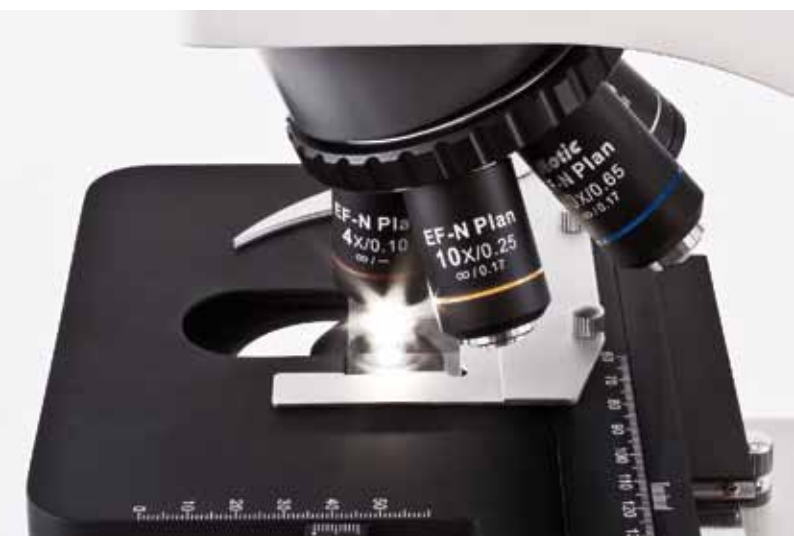

Illumination

The BA310 introduces a **new collector lens assembly** with a secure, screw-on holder for the frequently used Blue daylight filter which is an integral part of the illumination package. The fixed cap prevents the filter from dropping when the instrument is stored.

The BA310 offers multiple illumination options, such as the **Koehler 6V/30W halogen or 3W LED**.



Eyepiece Tubes

Designed with an **ergonomic viewing angle of 30°** and incorporating an **interpupillary distance of 48-75mm**, the BA310 observation tubes **guarantee fatigue-free viewing for hours**. A large field of view (20mm) enables fast and comfortable screening. All standard eyepiece tubes now offer an extended “butterfly” swivel adjustment to increase the viewing height to accommodate individual user’s positioning.

The trinocular tubes allow digital documentation by using a wide variety of digital cameras, with 20/80 or optional 0/100 light splits for the trinocular exit.

Eyepieces

The new **standard eyepieces**, N-WF 10X/20 with **high eyepoint** for eyeglass wearers, also made of **high quality optical glass**, provide consistent diopter adjustment for both eyes. This enables perfect usage of reticles for measuring, counting, etc.

Lockable eyepieces prevent inadmissible removal and confirms Motic's dedication to **student proof quality**.

Description	F.N.
Widefield N-WF 10X	20
Widefield N-WF 12.5X	18
Widefield N-WF 15X	16

Condenser

To ensure the best possible illumination quality, BA310 has a **full Koehler feature** giving complete freedom to set the height of the condenser.

The following reticles are available:

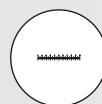

Graduated
linear hair point =
0.1mm/10mm

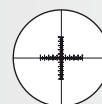

Graduated
cross hair point =
0.1mm/10mm



Plain cross hair

Stage

The BA310 surprisingly offers an **optional left/right hand control** and the new slide holder enables consistent sample movement across a 76 X 50mm range with a stage area of **175mm x 140mm**. The model also offers a hard coated surface, resistant against routine usage abrasion.

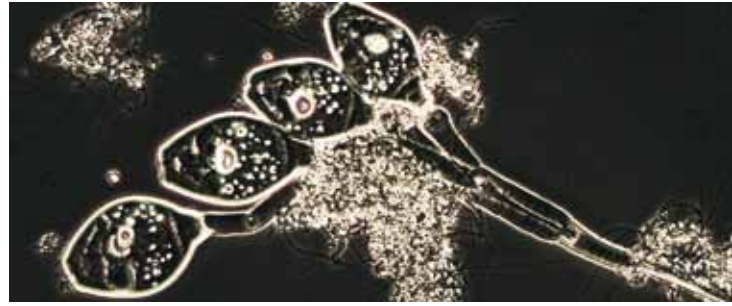

Multi Viewing Devices

The BA310 Series offers **multi-viewing teaching devices**. There are **two options** available, depending on the teaching situation in your laboratory; **face to face or side by side**.

The standard field of view of 20mm ensures that maximum information will be given to the student. Depending on the sample, the user can activate the **built-in LED pointer** in red or green color.



Polarization

Convenient and easy, the BA310 polarization system consists of a **polarizer**, placed on top of the collector lens, and the **analyzer** placed between the head and body.

Anti-Fungus Design

To protect the system from fungus growth in high-humidity environments, an **anti-fungus treatment** is applied to prolong the life of both microscope and objectives.



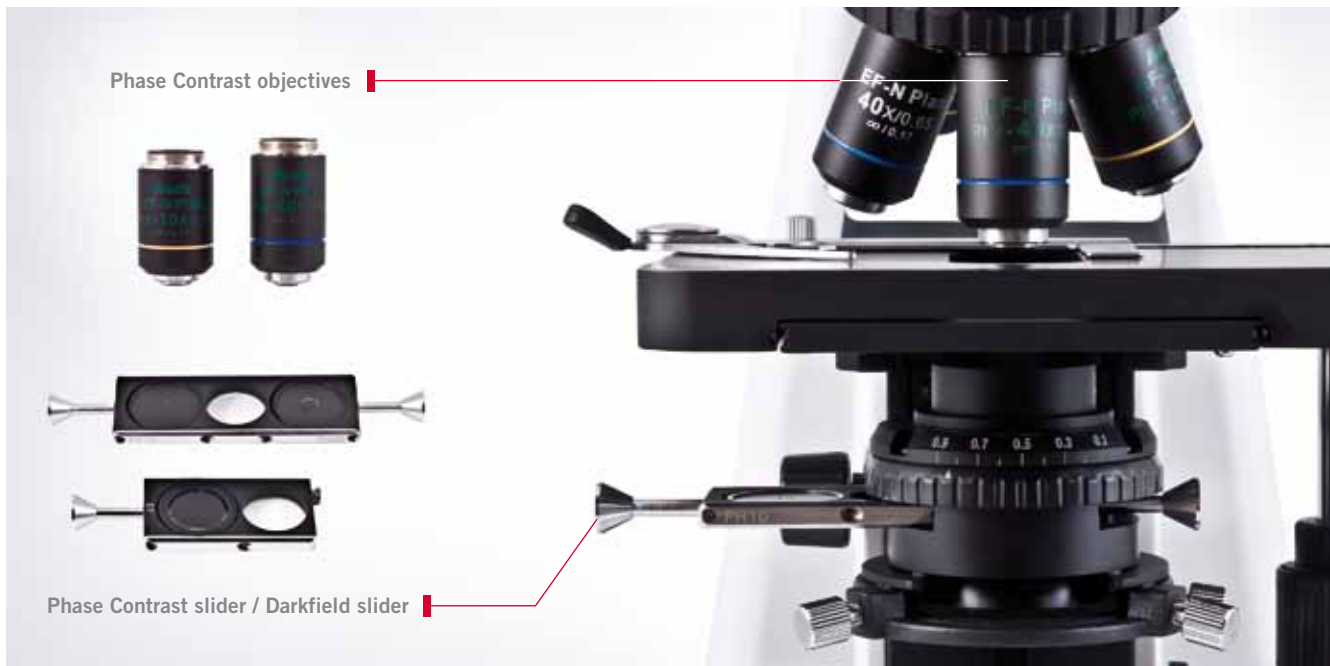

Phase Contrast objectives

Phase Contrast slider / Darkfield slider

Phase Contrast and Darkfield

Phase Contrast - Slider solution

Offered as an option, phase contrast is available for objectives EF-N Plan Phase 10X/0.25 and EF-N Plan Phase 40X/0.65.

Darkfield - Slider solution

Darkfield is possible with a separate DF slider (up to 40X, max. N.A. 0.65).

Phase Contrast - Turret condenser

This Turret condenser contains the light rings for all EC-H Phase lenses 10X/20X/40X/100X as well as a Dark field stop and a Bright field position.

The corresponding objectives are:

CCIS® EC-H Plan Phase Objectives	W.D.
PL Ph10X/0.25	17.4mm
PL Ph20X/0.45	0.9 mm
PL Ph40X/0.65	0.5 mm
PL Ph100X/1.25 Oil	0.15 mm



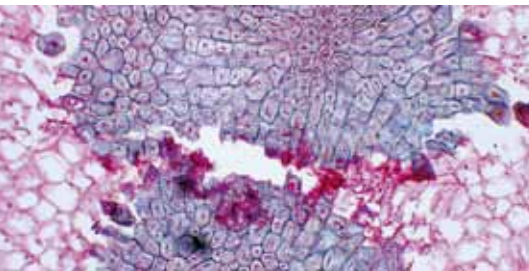

Documentation

The importance of documentation has expanded into every aspect of microscopy, as has the method of documentation. The BA310 is available with both a traditional method (photomicrography) and a digital method.

Standard Photomicrography

The traditional use of a **single lens reflex camera** (analogue or digital) requires the trinocular version of the BA310. The adaptation of the camera consists of a **mechanical adapter** combined with a **photo eyepiece** (2.5X or 4X)

The necessary **T2 adapter** referring to the camera model is supplied by the **camera manufacturer**. This setup delivers **high resolution images of small fields**.



Digital Documentation

Digitalization of microscopic results is Motic's philosophy and the BA310 provides **two methods**.

The combination of the BA310 trinocular microscope **with the Moticam Series** of digital cameras delivers crisp live images easy to be saved. **All Motic cameras come equipped with software** to convert the BA310 into an analysis and documentation station. Should you select a third-party camera, Motic provides **a range of CCD-adapters** covering all demands for field vs. resolution.

Another digitalization option is the **BA310 digital head**. Replacing the conventional head with the Digital head transforms the BA310 into a **teaching, training, and analysis station** without the hassle of adapters and focus corrections. **With a USB2.0 output** to the computer, the system provides **high resolution imaging in both real time and capture modes**.



BA310

Schematic Diagrams Unit: mm

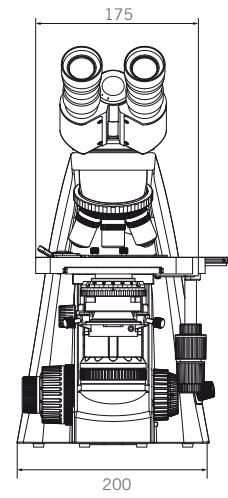
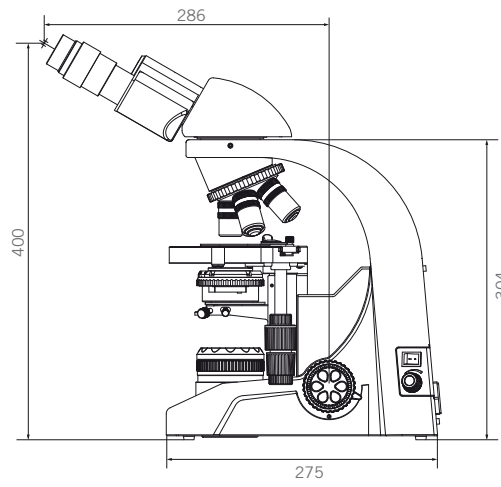

BA310 Digital

Schematic Diagrams Unit: mm

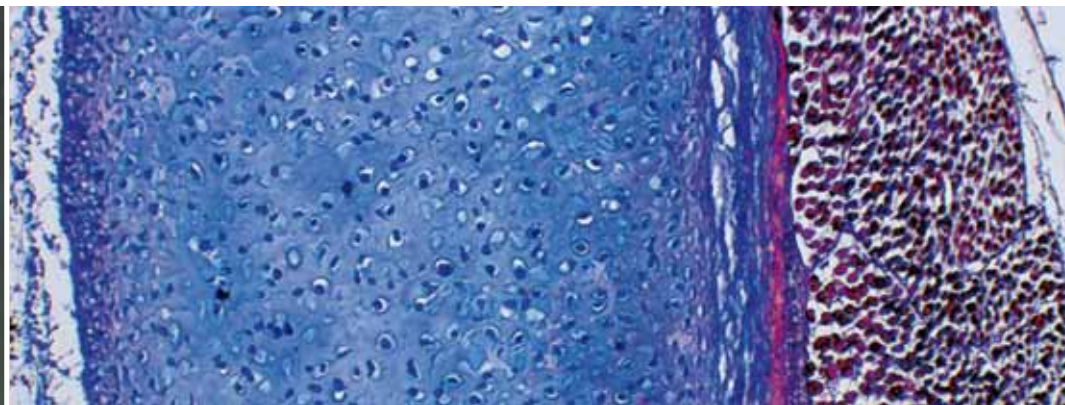
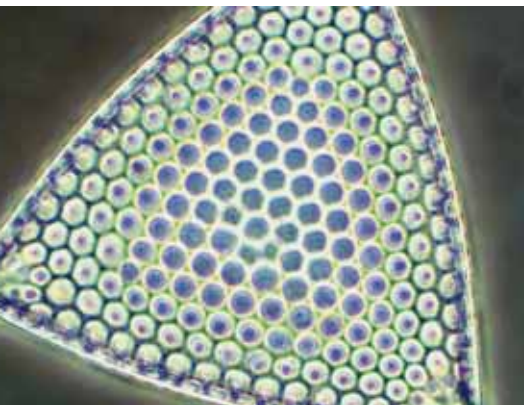
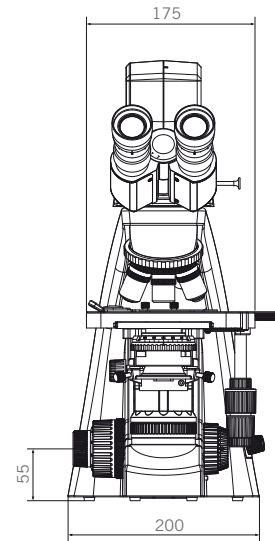
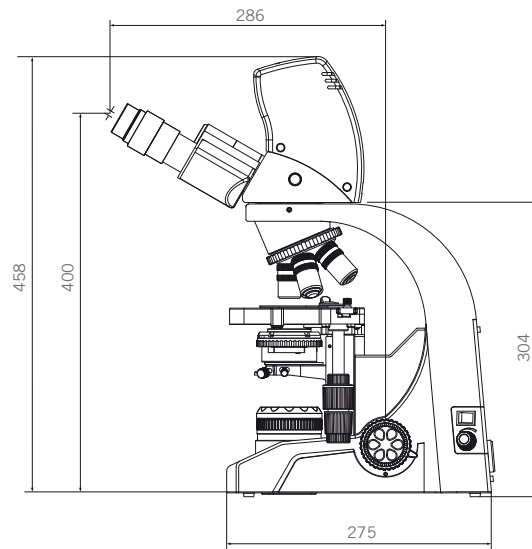

BA310 Standard Specifications

Model	BA310
Optical System	Color Corrected Infinity Optical System [CCIS®]
Observation Tube	Widefield binocular 30° [F.N. 20] Widefield trinocular 30° [F.N. 20]- light distribution 100:0/20:80 Widefield trinocular 30° [F.N. 20]- light distribution 100:0/0:100
Nosepiece	Reversed quintuple
Stage	175 x 140mm surface; 76 x 50mm movement; coaxial controls
Condenser	N.A. 0.9 / 1.25 Abbe condenser with slider slot; Focusable and Centerable
Focus	Brass gears Z-Axis movement 20 mm. Fine focus with 2µm minimum increment, Coarse focus with torque adjustment Stage lock for high samples, freely definable
Illumination	Built-in transmitted 6V/30W halogen Koehler illumination Built-in transmitted 3W LED Koehler illumination; >10,000 hrs bulb life span

BA310 Digital Standard Specifications

Model	BA310 Digital	
Optical System	Color Corrected Infinity Optical System [CCIS®]	
Observation Tube	Widefield binocular 30° [F.N. 20] with built-in 3 megapixel digital camera-light distribution 100:0/20:80	
Camera Specifications	Effective Pixels	3.0 Megapixels
	Live Image Resolution	2048 x 1536
	Data Transfer	480 Mb / Second USB 2.0
	White Balance	Manual adjustment by using software
	Recommended System	Windows: XP, Vista or 7; P4 1.0GHz 256MB RAM, USB 2.0
	Requirements	Mac: OSX, 1.0GHz 256MB RAM, USB 2.0
	Software	Motic Images Plus 2.0

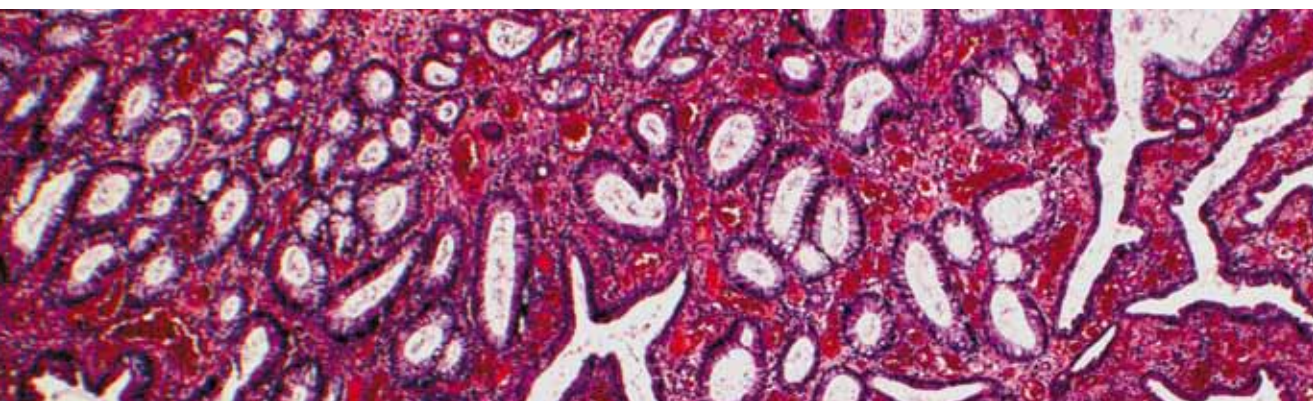

BA310 System Diagram

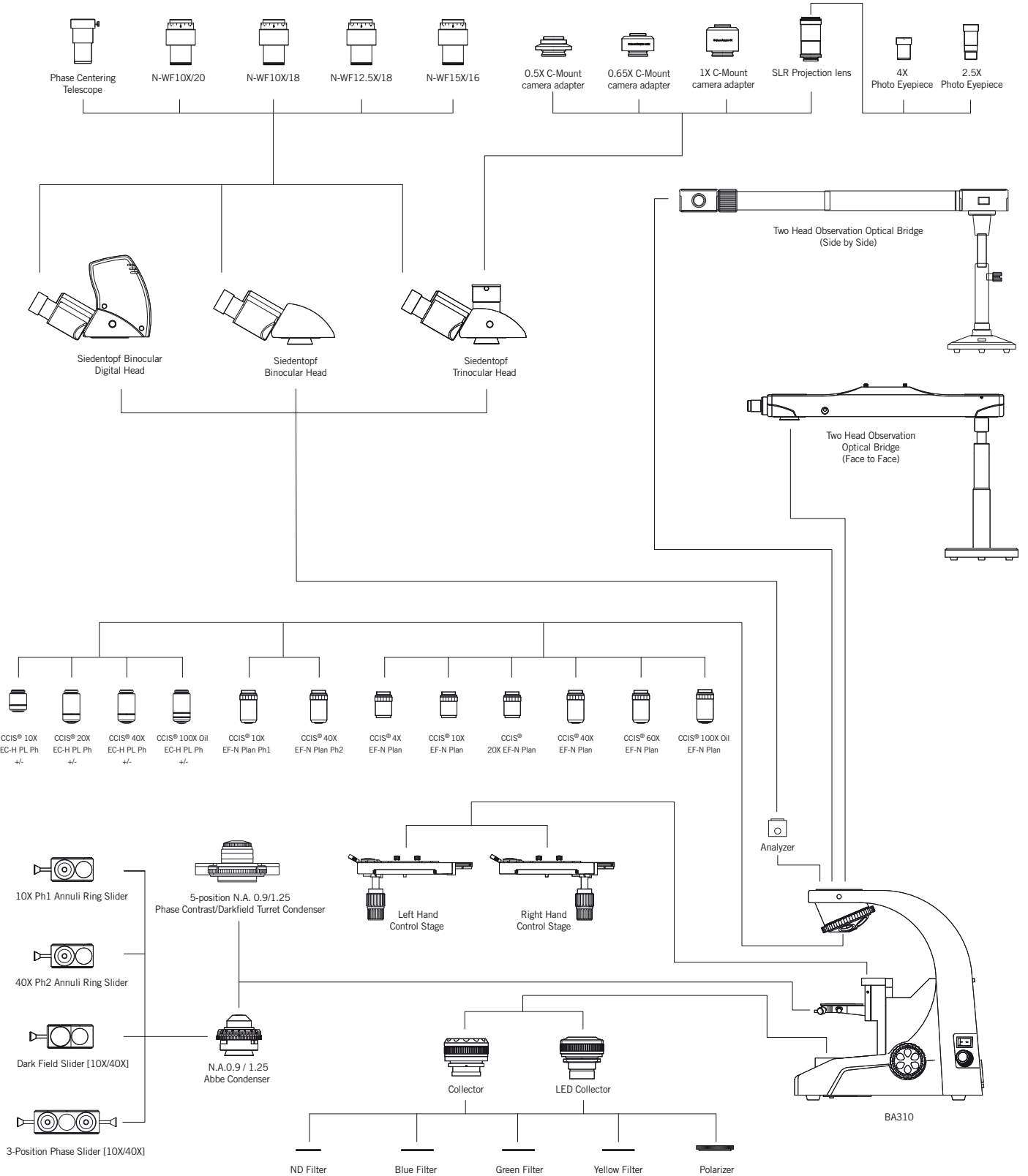



Canada | China | Germany | Spain | USA

Motic®

www.motic.com

Motic Instruments (CANADA)

130 - 4611 Viking Way. Richmond, BC V6V 2K9 Canada
Tel: 1-877-977 4717 Fax: 1-604-303 9043

Motic Deutschland GmbH (GERMANY)

Christian-Kremp-Strasse 11, D-35578 Wetzlar, Germany
Tel: 49-6441-210 010 Fax: 49-6441-210 0122

Motic Incorporation Ltd. (HONG KONG)

Rm 2907-8, Windsor House, 311 Gloucester Road,
Causeway Bay, Hong Kong
Tel: 852-2837 0888 Fax: 852-2882 2792

Motic Spain, S.L. (SPAIN)

Polígono Industrial Les Corts, Camí del Mig, 112
08349 Cabrera de Mar, Barcelona, Spain
Tel: 34-93-756 6286 Fax: 34-93-756 6287

* **CCIS®** is a trademark of Motic Incorporation Ltd.

**Motic Incorporation Limited Copyright © 2002-2010.
All Rights Reserved.**

Design Change :

The manufacturer reserves the right to make changes in instrument design in accordance with scientific and mechanical progress, without notice and without obligation.



Updated: July 2011

